

# EUROPE'S LEADING SPARE PARTS GROUP

*The one-stop provider  
for catering spares*





*[www.gev-online.com](http://www.gev-online.com)*  
*[www.lfspareparts724.com](http://www.lfspareparts724.com)*  
*[www.epgc.com](http://www.epgc.com)*  
*[www.ccspares.co.uk](http://www.ccspares.co.uk)*  
*[www.atelitalia.com](http://www.atelitalia.com)*



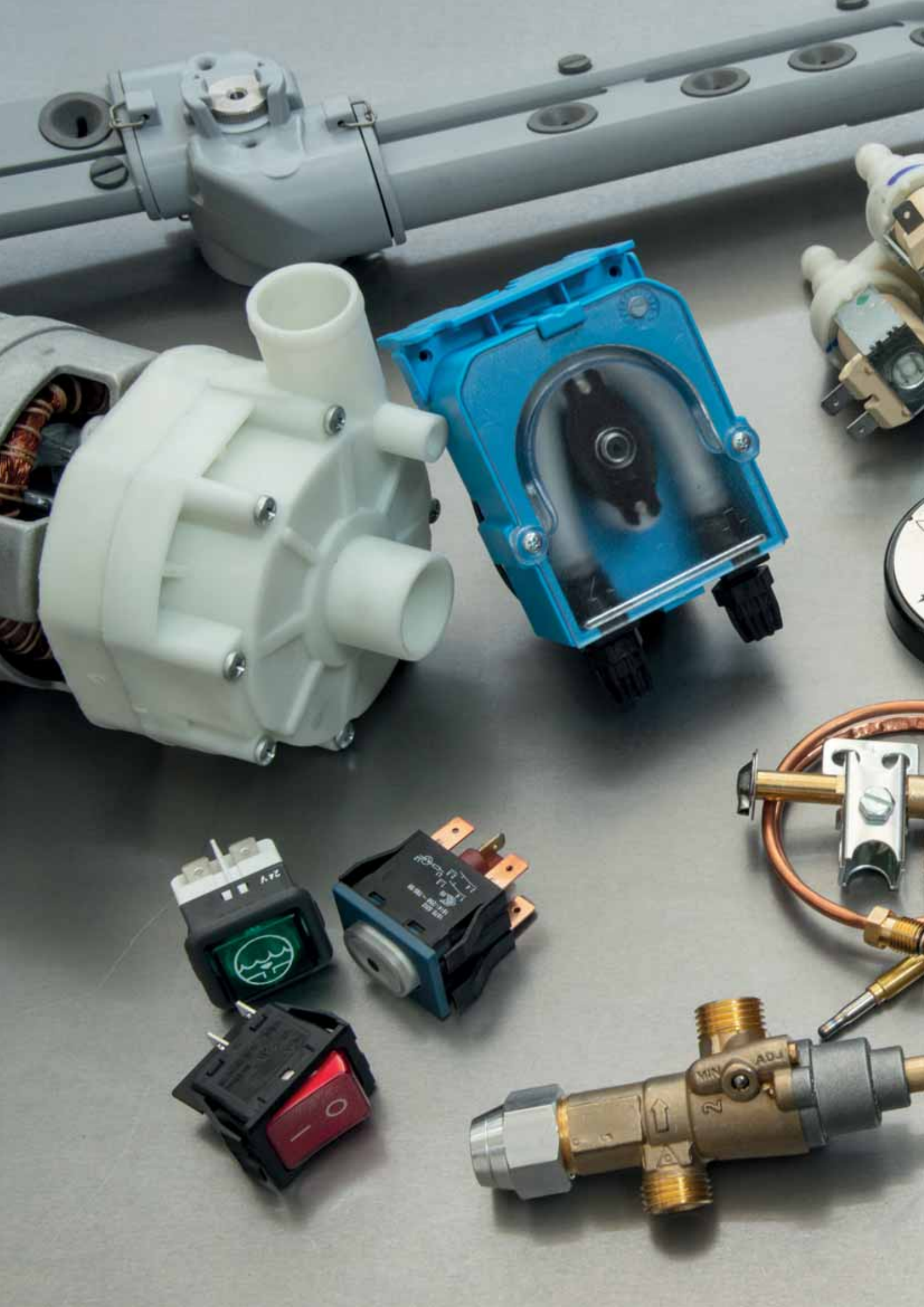

# REPA THE SPARE PARTS GROUP

## Joint future

Since we joined forces in 2018, we have become the strongest provider of spares for professional catering appliances in the European market.

Our customers benefit daily from all the synergies that partnership brings: with access to an unrivalled joint product portfolio, automated warehouses around the globe and proven technical and industry expertise – we are the no. 1 partner for spares in the Catering industry.

## Individual histories

With individual success stories and experience in different sectors, we combine over 200 years of industry experience.

Each company brings an extremely strong product portfolio and its own area of expertise to the partnership, covering sectors from HoReCa, Refrigeration, Coffee, Vending to local market expertise.

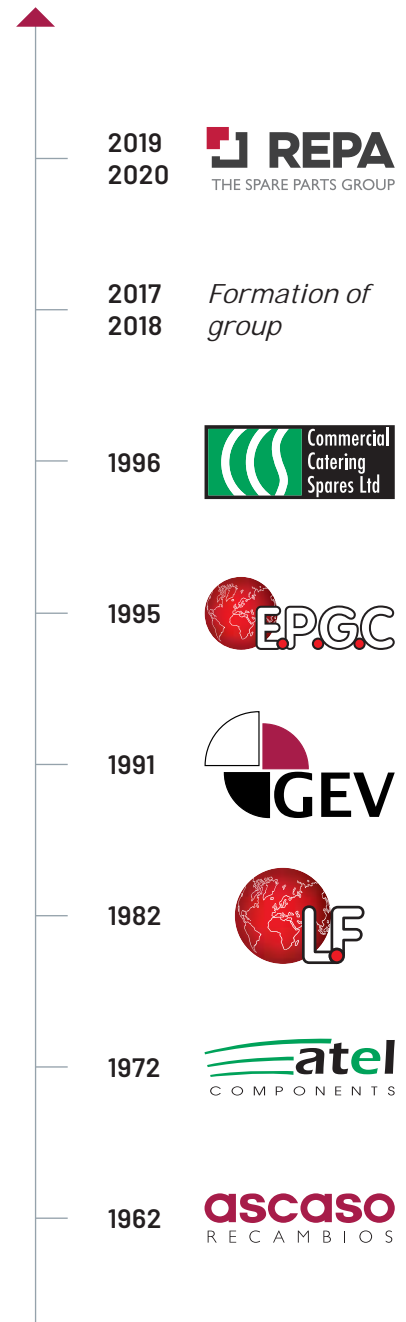

“ *We simplify our customers' lives every day, worldwide, by providing them with a truly one-stop shop for catering equipment spares, based on state-of-the-art logistics and the highest service levels.* ”

# WE ARE WHERE OUR CUSTOMERS ARE

*Dedicated teams around the globe*

## **Our teams**

Our global team of 740 highly qualified employees consisting of technical and logistical experts, purchasing and customer service professionals are proven experts in their fields and make our group the success it is.

Whether our customers have a technical question, a query relating to an order or need assistance in finding the correct item, our team is here to provide support - in over 20 languages.



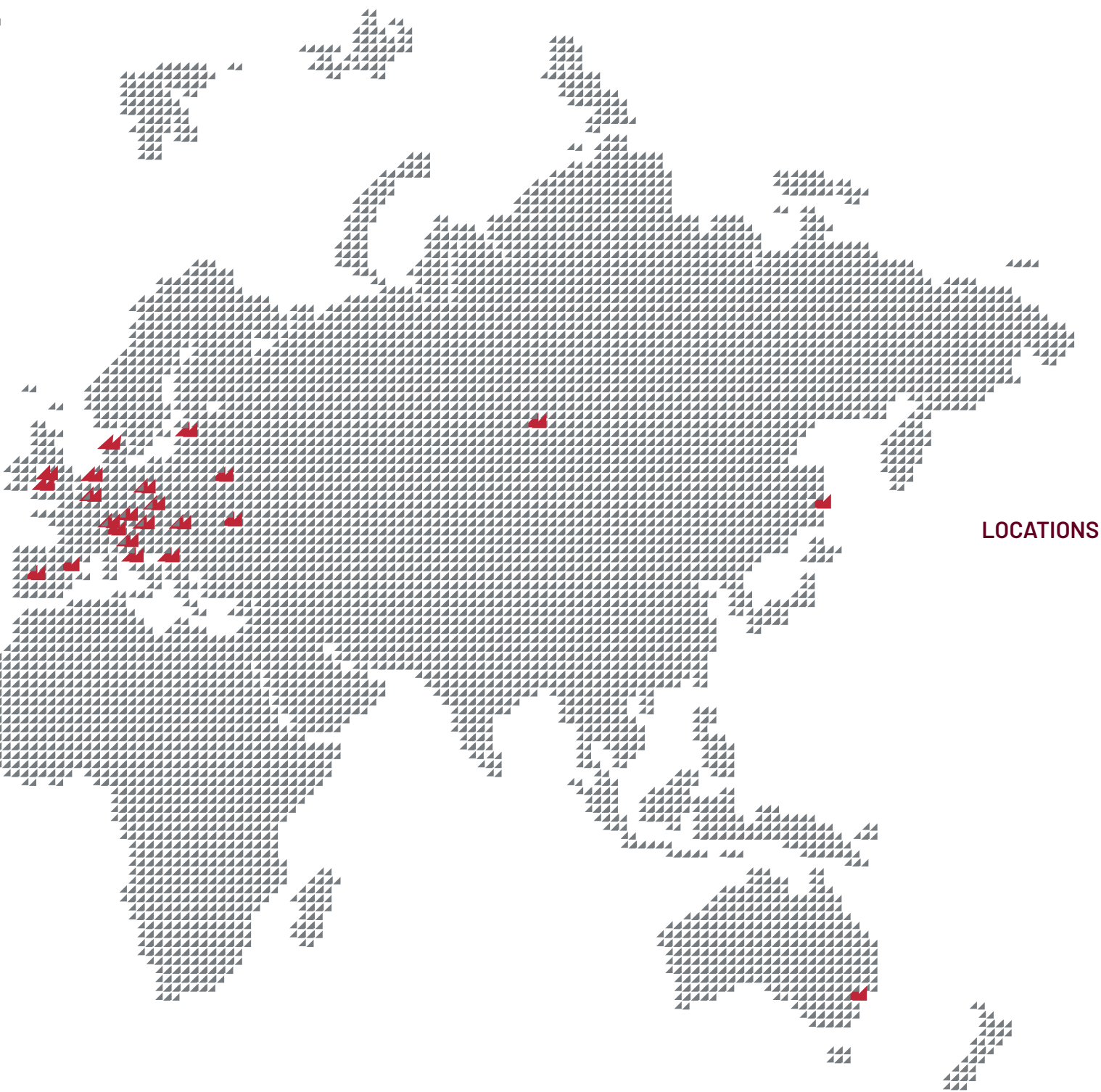

**Our offices. Our network.**

With over 20 offices and more than 50 local distribution partners around the world as well as more than 50 sales agents on the road, we are right where our customers need us.

# SIMPLE SEARCH

## **Finding the right part has never been easier**

Our online shops are specifically designed to assist our customers in finding the right spare part at all times.

With multiple search options, innovative features and functionalities, we strive to make our customers' lives easier by providing a positive and stress-free searching and ordering experience online.

Can't find the right part? Our experts are on hand to help!

## **Apps for on the road**

Always on the road? Our apps enable service technicians to search for and order spare parts and accessories directly from their mobile devices.



FAST  
DELIVERY

---

### High availability. Fast delivery.

---

- 97% availability overall
- 99%+ for A-parts
- Automated logistics systems
- Own production facilities
- Next-day delivery all over Europe

---

### Tailored to individual needs

---

- Standard delivery
- Express delivery
  - Next-day delivery
  - Early-morning delivery
  - Saturday delivery
- ByBox, SLS and Access Point Delivery
- Pick-up at the local warehouse
- All major transporters & carriers
- Customs clearance processing service

WORLDWIDE DELIVERY

# PARTNER SERVICES

[partner@gev-online.com](mailto:partner@gev-online.com)

## Beyond spares

### OUR SOLUTIONS FOR MANUFACTURERS

#### Original equipment manufacturers rely on us for a reason

We help to support and grow our partners' businesses by managing their spare parts programme with 100% OEM parts. From order and data management, invoicing and customer service through to logistics and marketing communication, we have dedicated service teams in place for our partners.

---

#### Advantages for OEMs

---

- We push your spare parts service to another level
- 100% OEM parts
- Enable maximum product availability for your portfolio
- Reduce your stock and logistics costs
- Access our global sales network
- Benefit from local warehouses worldwide
- Profit from our end-to-end customer-centric solutions
- Utilise our technology-driven logistics operations
- Receive dedicated state-of-the-art warehouse management solutions
- Enrich your market intelligence with our knowledge
- Participate in co-marketing opportunities to extend your market reach



---

# OUR PORTFOLIO

# REFRIGERATION

## High-quality original components

We as a group are especially proud of our extremely strong portfolio of spares and accessories for refrigeration equipment, which includes more than 30,000 items selected by our refrigeration experts across Europe.

The refrigeration team works closely with manufacturers, customers and our sales experts, ensuring the range is constantly extended, for example for brands such as AKO, Castel, Cubigel, Danfoss, Dixell, Eliwell, Embraco and Pego to name just a few.

OVER 175 BRANDS



## Spare parts and accessories for

- Blast chillers
- Granita machines
- Cold cabinets
- Ice cream machines
- Cold rooms
- Ice makers
- Coolers
- Refrigerated cases
- Freezers
- Cold trolleys & counters
- and many more

# GASKETS

for Refrigeration

OUR SPECIALITY

## Gaskets for refrigerators, cold rooms and blast freezers

We stock over 1,300 standard gaskets in over 200 profiles available for next-day delivery as well as customised gaskets in over 140 profiles.

Customised gaskets are produced in our own facilities, which enables us to maintain our high quality standards and ensure delivery in just 2-4 working days.



## Gasket configurators

With our online gasket configurators, finding and ordering customised gaskets is quick and easy - including instant price calculation.

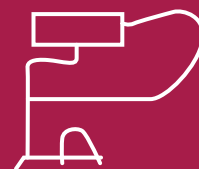
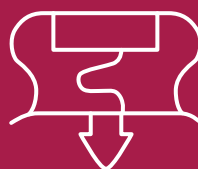

# DISHWASHING

## Helpful technical descriptions for dishwashing parts

Over 30,000 dishwashing-related parts are displayed in our online shops. Detailed technical descriptions and over 14,000 exploded views facilitate easy part selection and installation.

We stock a wide array of parts, from heating elements, pumps, dosing pumps, and wash- and rinse arms to gaskets, as well as an extensive range of dishwasher accessories, to ensure dishwashers run smoothly and disruption times are minimised.

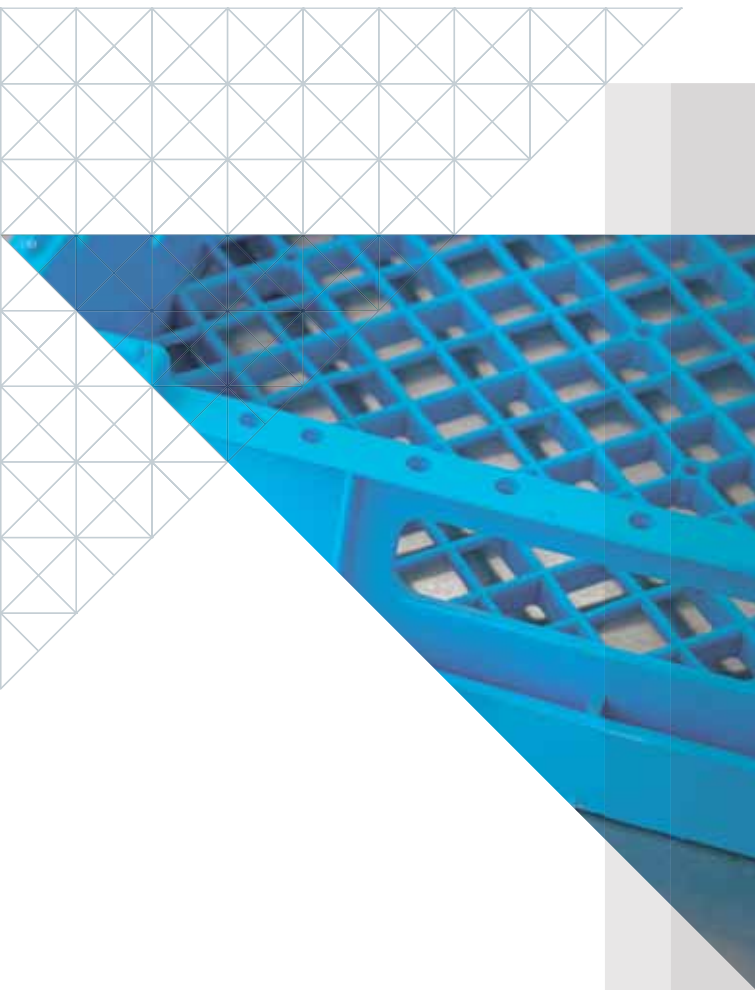

## Spare parts and accessories range

- Heating elements
- Pumps
- Dosing pumps
- PCBs
- Wash & rinse arms
- Gaskets
- Hoses
- Baskets
- Drain systems
- Pressure reducers
- In-line particle & water filters
- Screw pipe fittings
- Detergents & softeners
- Base frames
- and many more

## TECHNICAL DESCRIPTIONS

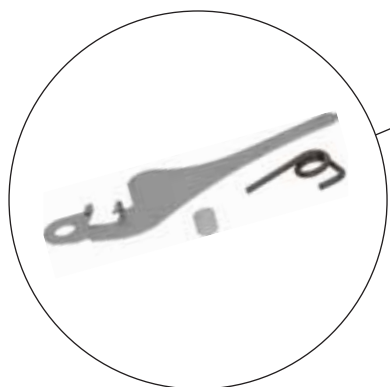
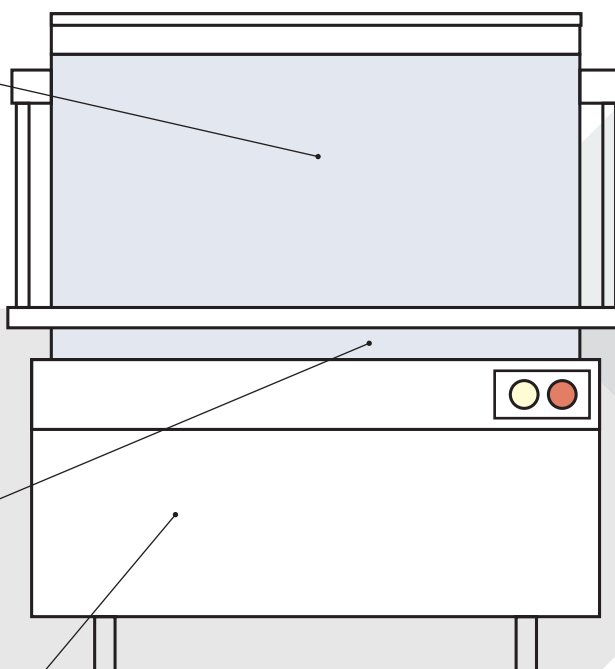

### Suitable for

COLGED

DIHR

ELFRAMO

ELECTROLUX

FAGOR

HOBART

HOOVED

MEIKO

WINTERHALTER

# OVENS

## A wide range of oven spares in stock

Heavily-used appliances like combi and convection ovens are subject to wear and tear in every professional kitchen. We stock over 12,000 parts and accessories to ensure professional equipment for over 50 brands can be repaired in no time.



ALWAYS IN STOCK



### Suitable for

- Angelo Po
- Convotherm
- Electrolux
- Fagor
- Giorik
- Hounö
- Lainox
- MKN
- Rational
- Retigo
- Unox
- and many more



## Easy identification of parts

Exploded views and parts lists for over 13,000 oven appliances help our customers find the right part.

### EXPLODED VIEWS

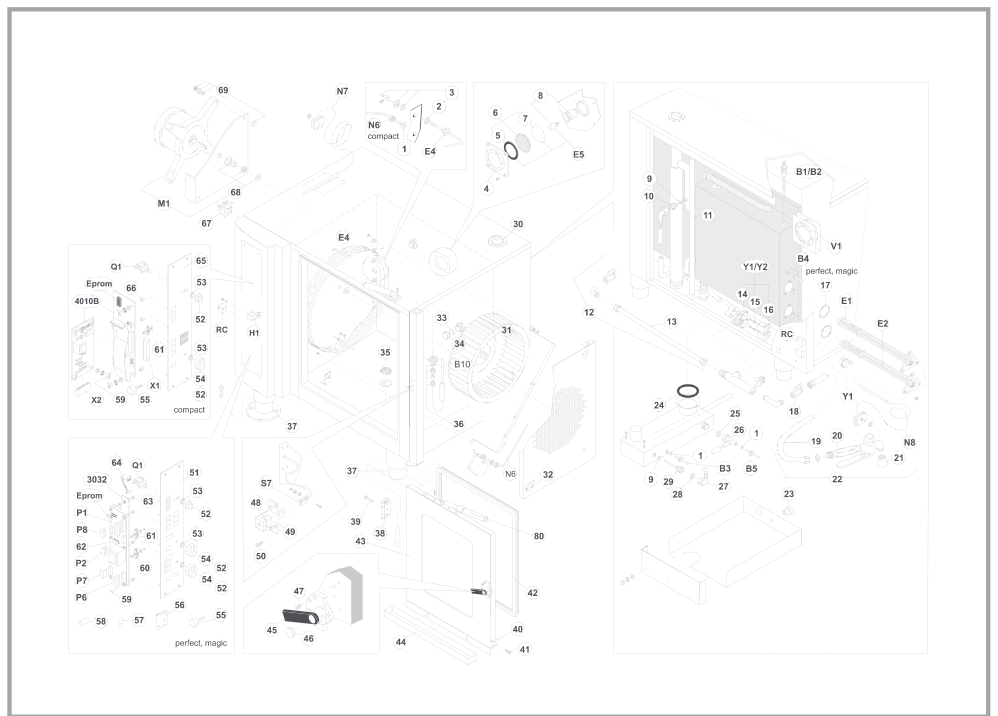

## Gaskets for ovens

Perfectly matched, high-quality seals allow for heavy oven use and optimal results.

Our comprehensive range of spares for cooking units includes gaskets and seals for oven doors, windows, tray racks, trolleys and control panels.



# COOKING

## Constantly updated cooking range

Our customers rely on us for the high availability and fast delivery of spare parts, especially for critical and frequently required parts. That's why we constantly update and improve our cooking range to meet market demands.

We stock a vast range of essential spare parts for appliances such as stoves, fryers, grills or induction cookers available for next-day delivery.



OVER 200 COOKING BRANDS

## Suitable for

- Alto-Shaam
- Angelo Po
- Baron
- Bartscher
- Bonnet
- Charvet
- Cooking Systems
- EKU
- Electrolux
- Eloma
- Elframo
- Falcon
- Frymaster
- Garland
- Henny Penny
- Hugentobler
- Imperial
- Lincat
- Mareno
- MKN
- Modular
- Nayati
- Olis
- Öztiryakiler
- RM Gastro
- Stierlen
- Unox
- and many more



QUALITY SPARES

## A complete range of items for food preparation

We offer a huge number of spares and accessories required for food preparation and processing in our online shops. Our high-quality spares will help extend the lifespan of professional food preparation appliances.

If technicians need help identifying the right part, we have dedicated service teams ready to help.

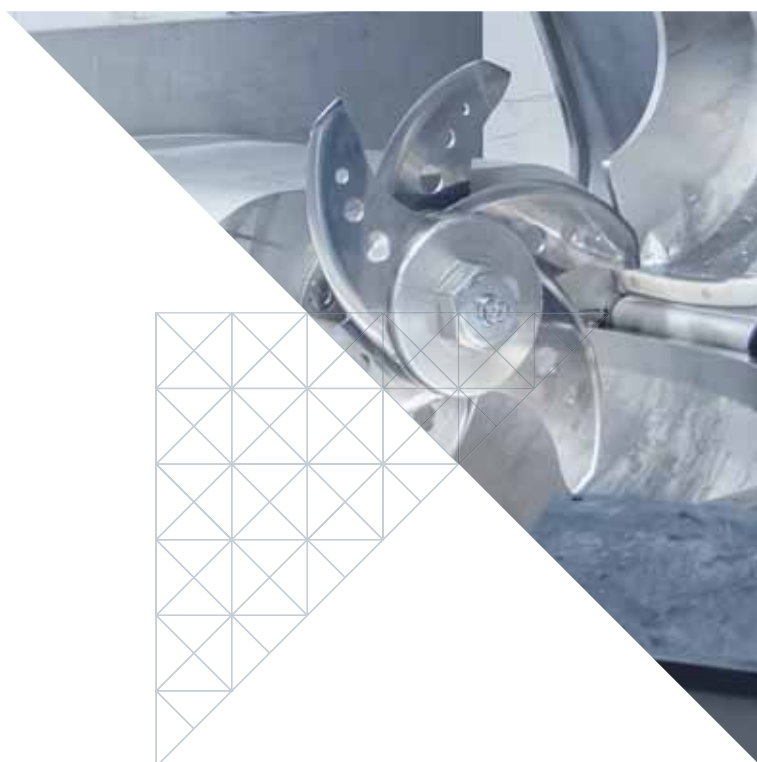

## Suitable for

- Slicing machines
- Vacuum packers
- Vegetable cutters
- Graters
- Kneaders
- Planetaries
- Vegetable washers
- Mixers
- Potato and mussel cleaners
- Bonesaws
- Meat mincer and filler cones
- Berkel
- Dito
- Electrolux
- Fama
- Fimar
- Kenwood
- KitchenAid
- Rheninghaus-Tecmal
- Robot-Coupe
- Sammic
- Sirman
- and many more

# PRE- RINSE UNITS



## **Pre-rinse units for every need, for long-lasting use**

We pride ourselves on offering top quality products in all price categories. Our pre-rinse units are no exception. Made from the best materials to ensure long-lasting use, we offer a wide range of designs and different lines.

Through strict quality management and continuous product improvement, all our products are user-friendly and reliable.

INOX

Stainless steel spring

Stainless steel stripwound hose  
for bend protection on both sides

Wall holder

Spring holder  
adjustable in height

Spray valve holder  
adjustable in height

Practical  
spray gun

MADE FROM STAINLESS STEEL

EASY CLEANING

MEETS HIGHEST HYGIENE REQUIREMENTS

IN-HOUSE ASSEMBLY

# COFFEE

## Coffee essentials

We have an extensive range of spare parts and accessories for all kinds of coffee machines to meet all installation, maintenance, repair and cleaning requirements.

From coffee grinders, filter holders and boiler valves to brushes, clamps, electric pumps, pressure switches and tampers – everything our customers require and more.

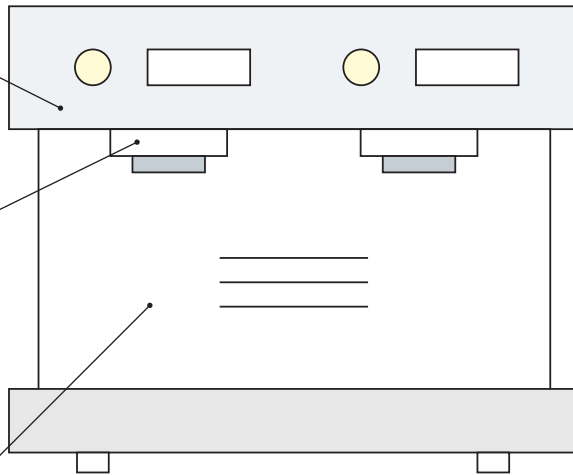

---

## Spare parts and accessories for

---

- Espresso coffee machines
- OCS coffee machines
- Commercial coffee grinders
- Pod coffee machines
- Capsule coffee machines
- Filter coffee machines
- Vending coffee machines
- and many more

Because we are so passionate about the world of coffee, we have invested in our own line of coffee cleaners and have extended our Barista tools range to include our own products.

### **Baristapro - 100% Italian!**

Baristapro is our own product series specially developed for baristas. The items are carefully designed and tailored to their daily needs, providing new solutions and improving the quality of the product they offer to the customer.



# OUR BRANDS

*for Baristas*



### **Coffee clean by LF**

Regular cleaning and maintenance of commercial coffee machines is absolutely vital in the catering trade. That is why we sell our own line of coffee cleaners and have extended our cleaning range to include organic cleaners, descaling products for grinders, filters and showers.

# VENDING

## We keep vending machines working

We work together with the leading manufacturers in Europe and beyond to supply our customers with over 15,000 of the most sought-after vending spares - from solenoid valves and electro pumps to heating elements and gear and fan motors.

15,000 PARTS

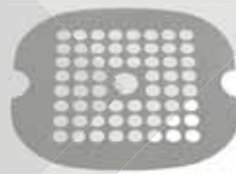

SUPERAUTOMATIC COFFEE MACHINES

COFFEE MACHINES (OCS)

COLD VENDING MACHINES

SNACK VENDING MACHINES



CONSTANTLY UPDATED VENDING RANGE

---

### Suitable for

---

- Bianchi Vending
- Fas
- Lavazza
- Necta
- Rheavendors
- Saeco
- Sielaff
- Wittenborg
- Azkoyen
- and many more

... and coffee kitchens, too

---

### Suitable for

---

- De' Longhi
- Didiessa
- Grimac
- Lavazza
- Nespresso
- Panafe
- SGL
- Spinel
- and many more



# ACCESSORIES

## More than just spare parts

In a true one-stop shop manner, we offer thousands of accessories and consumables covering all sectors from refrigeration to dishwashing, from cooking to coffee.

## Readily available

- Fryer and pasta baskets
- Dishwashing baskets
- Baking sheets
- Gastronorm containers
- Refrigerator grids
- Handles, locks and hinges
- Wheels
- Mounting and installation tools
- Measuring equipment
- and many more

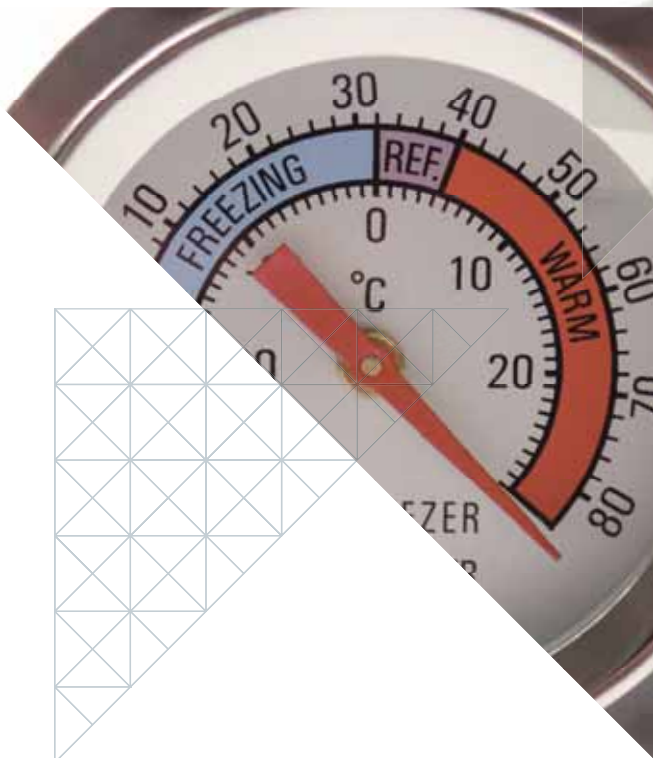

## Major manufacturers

- Cambro
- Steinco
- Tente
- Rothenberger
- Benning

# CONSUMABLES

IDEAL TO STOCK

## Also available

- Sprays
- Sealants and adhesives
- Lubricants
- Heat-conducting pastes
- Cleaning agents
- Regeneration salt
- Substitute resins
- Water filters
- and many more

## Major manufacturers

- |             |                    |
|-------------|--------------------|
| ■ Puly Caff | ■ BWT water + more |
| ■ Urnex     | ■ Henkel / Loctite |
| ■ Cafetto   | ■ Tomabond         |
| ■ Brita     | ■ Ottoseal         |
| ■ Pentair   | ■ and many more    |

# LAUNDRY



## Spare parts and accessories

- Heating elements
- Drain solenoid valves
- Laundry door gaskets
- Electronic boards
- Drain pumps
- Dampers
- Electromagnets
- Motor brushes
- Belts
- Solenoid valves
- and many more

## Industrial and commercial laundry

From laundry machines to dryers and ironing equipment: we offer an extensive range of spare parts suitable for commercial or industrial washing machines.

Whether customers decide to stock up in advance or rely on our high stock volume, we ensure that all required spare parts are with our customers on time.



## Suitable for

- Electrolux
- Fagor
- Girbau
- Imesa
- Ipso
- Miele
- and many more

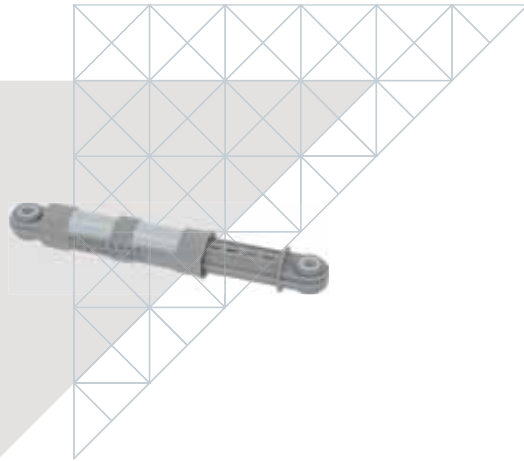

## DOMESTIC SECTOR

### Household appliances

In addition to servicing the professional catering industry, our range also includes spares for the household sector - which makes us the only provider to cover both markets.

---

### Spare parts and accessories for

---

- Home coffee machines
- Dishwashers
- Freezers and fridges
- Ovens and cooker tops
- Extractor hoods
- Microwaves
- Vacuum cleaners
- Washing machines and dryers
- and many more







*[www.gev-online.com](http://www.gev-online.com)*  
*[www.lfspareparts724.com](http://www.lfspareparts724.com)*  
*[www.epgc.com](http://www.epgc.com)*  
*[www.ccspares.co.uk](http://www.ccspares.co.uk)*  
*[www.atelitalia.com](http://www.atelitalia.com)*





**GEV Großküchen-Ersatzteil-Vertrieb GmbH**

Gadastr. 4  
85232 Bergkirchen - Germany  
T +49 8142 6522-50  
info@gev-online.com  
www.gev-online.com

**LF S.p.A. a socio unico**

Via Voltri 80  
47522 Cesena FC - Italy  
T +39 0547 341111  
info@lfspareparts.com  
www.lfspareparts724.com

**EPGC S.a.s.**

13 Rue des Forts  
59960 Neuville en Ferrain - France  
T +33 3 20250621  
epgc@epgc.com  
www.epgc.com

**Commercial Catering Spares Ltd.**

Block C - Axis Point Hill Top Road  
Heywood - Lancashire - OL10 2RQ - UK  
T +44 1706 621 155  
info@ccspares.co.uk  
www.ccspares.co.uk

**Atel S.r.l. a socio unico**

Via Selvuzzis 51/2  
33100 Udine UD - Italy  
T +39 0432 602095  
info@atelitalia.com  
www.atelitalia.com

LF3DT47

LF3DT47



P022323100